



**Technical Data**

**SierraSeries®  
MAXIMUM-HEIGHT  
WATER- AND FIRE-RESISTANT  
SOLID COLOR REINFORCED COMPOSITE  
PARTITIONS AND SCREENS**

**2090  
SERIES**

**Specify Product Application:**

- Toilet Partitions
- Dressing Compartments
- Shower Dividers
- Urinal Screens
- Entrance Screens
- With Outswing Door
- With Institutional Hardware (.67)

**Specify Series Required:**

- 2091 Series Floor-Anchored
- 2092 Series Overhead-Braced
- 2093 Series Post-to-Ceiling (Screens only)
- 2096 Series Floor-to-Ceiling Anchored

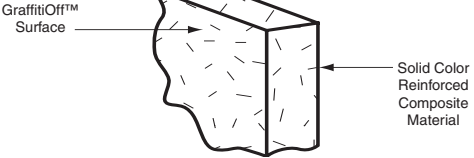

**STANDARD-SIZE COMPONENTS:**

**Stiles:** For compartments — 7", 8"<sup>a</sup>, 10", 12", 16", 18", 20", or 24" (18, 20, 25, 30, 41, 46, 51, or 61cm) wide; for screens — 6" (15cm) wide. **Floor-anchored** — 75-5/16" (194cm) high in any increment; **overhead-braced** — 83" (211cm) high; **floor-to-ceiling anchored** — height as required.

**Doors:** 72" (183cm) high. **Inswing doors** are standard for 22" to 37" (56-94cm) widths in whole-inch increments. **Outswing<sup>b</sup> doors** are standard for 25" to 37" (64-94cm) widths in whole-inch increments.

**Panels:** For compartments — Up to 84" (213cm) wide; 72" (183cm) high. For ceiling-hung and post-to-ceiling screens — 24", 36", 48", or 60" (61, 91, 122, or 152cm) wide; 72" (183cm) high.

**Note:** If the width of the panel exceeds 60" (152cm) the panel will be two pieces and require an H Channel to obtain 72" (183cm) height requirement.

**Posts:** For 2093 Series post-to-ceiling screens only. 1-1/4" (3cm) square. 10 ft (305cm); cut to required height in field.  
<sup>a</sup> Minimum 8" (20cm) wide stile is required for all maximum-height compartments.  
<sup>b</sup> Use outswing doors to comply with local codes requiring access for physically disabled persons.

**COMPARTMENT AND SCREEN ELEVATIONS**

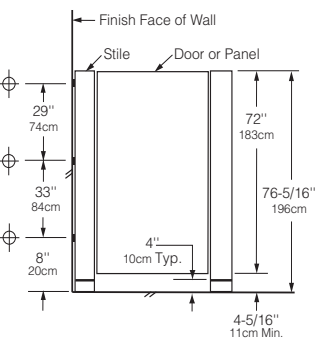

**2090 Series Floor-Anchored**

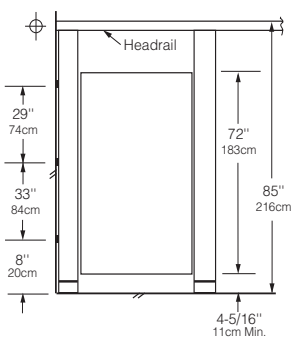

**2092 Series Overhead-Braced**

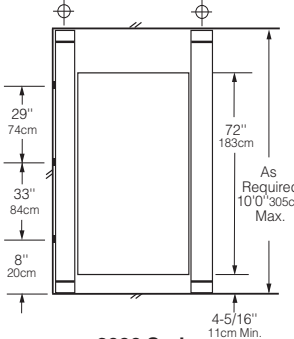

**2096 Series Floor-to-Ceiling Anchored**

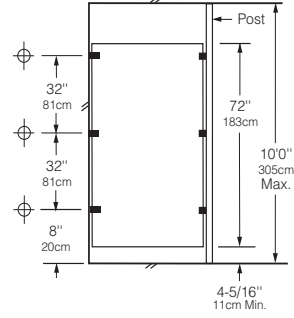

**2093 Series Post-to-Ceiling Screen**

⊕ These mounting points require backing. For suggested backing methods, Bobrick Advisory Bulletins TB-32 for ceiling-hung installations and TB-46 for floor-anchored are available upon request.

**TYPICAL HARDWARE DETAILS**

**Commercial Hardware (standard on all compartments)**

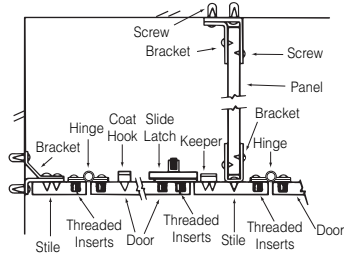

**Institutional Hardware (.67 option)**

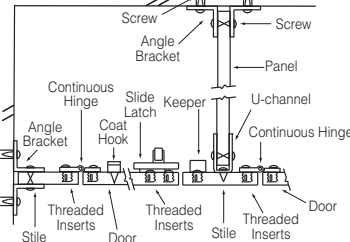

Standard gaps are provided at all walls and between components to allow for hardware attachment.

Wall gaps are standard 1/2" to 1"

**TYPICAL INSTALLATION DETAILS**

**Ceiling Leveling Device**

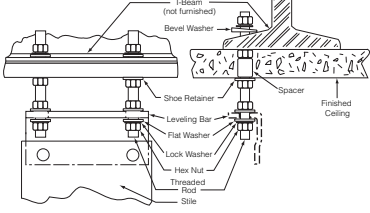

**Front Side**

**Floor Leveling Device**

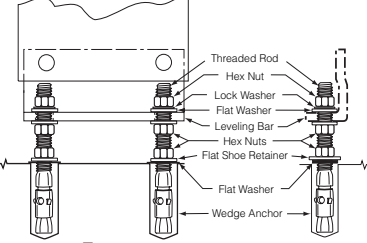

**Front Side**

**Overhead-Bracing**

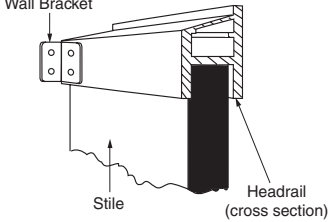

## MATERIALS:

**Stiles** — 3/4" (19mm) thick, Solid Color Reinforced Composite with GraffitiOff surface thermoset and integrally fused into one homogenous piece. Surface, edge, core are to be the same color. **Leveling Device:** 7 gauge, 3/16" (5mm) thick, corrosion-resistant, chromate-treated, double zinc-plated steel angle leveling bar bolted to stile; furnished with 3/8" (10mm) stainless steel diameter threaded wedge anchor, hex nuts, lock washer, flat washers, and shoe retainers. **Shoe:** 18-8, type-304, 22-gauge (0.8mm) stainless steel with satin finish; 4" (102mm) high.

*\*Stiles for 2096 Series floor-to-ceiling anchored units have a leveling device at each end.*

**Panels** — 1/2" (13mm) thick, Solid Color Reinforced Composite with GraffitiOff surface thermoset and integrally fused into one homogeneous piece. Surface, edge, core are to be the same color.

**Urinal Screens** — 1/2" (13mm) thick, Solid Color Reinforced Composite with GraffitiOff surface thermoset and integrally fused into one homogeneous piece. Surface, edge, core are to be the same color.

**Doors** — 3/4" (19mm) thick, Solid Color Reinforced Composite with GraffitiOff surface thermoset and integrally fused into one homogeneous piece. Surface, edge, core are to be the same color.

**Edges** — SCRC is a natural material comprised of wood chips, dyes and resins with a melamine surface. Edges lack a melamine surface and may discolor in environments with significant UV lighting. Discoloration of edges, should it occur, is not covered under warranty.

**Posts (for 2093 Series screens only)** — 1-1/4" (32mm) square tubing; 18-8, type-304, 18-gauge (1.2mm) stainless steel with satin finish. Floor and ceiling connections are constructed of 18-8, type-304, heavy-gauge stainless steel. Furnished in 10-ft (305-cm) lengths; to be cut in field to job specifications.

**Headrail (for 2092 Series compartments only)** — Extruded anodized aluminum with satin finish. Enclosed construction with sloping top. Face has raised grip-resistant edge.

*Designer's Notes:* Headrails with integral curtain tracks and hooks are available for compartments without doors. Optional vinyl curtains are available.

**Commercial Hardware (standard)** — Hinges, door latches, door keepers, clothes hooks, and mounting brackets are constructed of 18-8, type-304, heavy-gauge stainless steel with satin finish. Threaded inserts are factory installed for securing hinges, and door latches. Theft-resistant, stainless steel pin-in-head, torx screws are furnished for door hardware and all mounting brackets. Black rubber bumper on the latch serves as door bumper for inswing door. Balanced hinge is adjustable to hold door of unoccupied toilet compartment partially open or fully closed. Toilet compartment door is locked from inside by sliding door latch into keeper. A locked compartment may be opened from outside by lifting door to disengage latch from keeper. Track of door latch prevents inswing door from swinging out beyond stile; on outswing door, the door keeper prevents it from swinging in beyond stile.

**Institutional Hardware (.67 option)** — Hinges, door latches, door keepers, clothes hooks, U-channels, and angle brackets are constructed of 18-8, type-304, heavy-gauge stainless steel with satin finish: one-piece, full-height hinge is 16 gauge (1.6mm); one-piece door keeper is 11 gauge (3.2mm); one-piece, full-height U-channels and angle brackets are 18 gauge (1.2mm). U-channels secure panels to stiles, and angle brackets secure panels and stiles to walls. Door latch slides on a shock-resistant nylon track. A locked compartment may be opened from outside by lifting door to disengage latch from keeper. Theft-resistant, stainless steel pin-in-head, torx screws are furnished for door hardware, U-channels, and angle brackets. Doors are equipped with a self-closing hinge. Threaded inserts are factory installed to secure door hinge and latch. Mounting screws for stile-to-panel brackets and latch keeper connections are through-bolted. Track of door latch prevents inswing door from swinging out beyond stile; on outswing door, the door keeper prevents it from swinging in beyond stile.

*To specify Institutional hardware, add suffix .67 to series number. Example: specify 2092.67 for overhead-braced, maximum-privacy partitions furnished with Institutional hardware, including factory-installed threaded inserts for door hardware attachment.*

## INSTALLATION:

Bobrick installation instructions are packed with each shipment and are available also in advance on request.

### Notes:

1. Ceiling-hung and floor-to-ceiling toilet compartments require structural members (not furnished by Bobrick) in ceiling. For suggested types of ceiling support systems, see Bobrick Advisory Bulletin TB-32.
2. Wall backing is required to secure the mounting brackets of panels, stiles, and wall posts. For suggested wall backing, see Bobrick Advisory Bulletin TB-46.
3. Floor-anchored stiles are furnished with expansion shields and threaded rods. The expansion shields require minimum 2" (50mm) penetration into minimum 3" (75mm) thick structural concrete.
4. Bobrick stainless steel partition-mounted washroom accessories are available for mounting in panels between two compartments. See current Bobrick Catalog for description of accessories. Cutouts in panels can be pre-cut for Bobrick models at factory if location and size of all cutouts and Bobrick model numbers are furnished at time of order.
5. Note: If the width of the panel exceeds 60" (152cm) the panel will be two pieces and require an H Channel to obtain 72" (183cm) height requirement.

## GUARANTEE:

Bobrick toilet partitions including all hardware and mounting brackets are guaranteed to be free from defects in material and workmanship for a period of one year from date of purchase. Any products returned to Bobrick under this guarantee will be repaired or replaced at no charge. **25-Year Warranty:** Bobrick extends a twenty-five-year limited warranty from date of purchase for SierraSeries Solid Color Reinforced Composite partition panels, doors, and stiles against breakage, delamination and corrosion when materials are properly installed, and normally used.

## SPECIFICATION:

Water-resistant, solid color reinforced composite \_\_\_\_\_ (insert one: toilet partitions, dressing compartments, shower dividers, urinal screens, entrance screens) shall be \_\_\_\_\_ (insert one: overhead-braced, floor-to-ceiling anchored, ceiling-hung or floor-anchored, post-to-ceiling urinal screens). Stiles, panels and doors shall be constructed of Solid Color Reinforced Composite with GraffitiOff surface thermoset and integrally fused into one homogeneous piece. Surface, edges and core are to be same color. Solid Color Reinforced Composite material shall be covered by a 25-year limited warranty against breakage, corrosion, and delamination. Stiles and doors shall be 3/4" (19mm) thick; panels shall be 1/2" (13mm) thick. All units shall meet ICC and NFPA Class B or UBC Class II, ASTM E 84 Fire-Resistance Standards. Stiles shall have leveling device that is concealed by a one-piece, type-304, satin-finish stainless steel shoe that is 4" (102mm) high. Stiles, panels and doors shall be \_\_\_\_\_ (insert color name and number from current Bobrick catalog). Headrails for overhead-braced compartments shall be anodized aluminum with satin finish. "All door hardware and mounting brackets shall be type-304 stainless steel with satin finish. All doors shall be supplied with three hinges. Threaded inserts shall be factory installed for securing door hinges and latches. Theft-resistant, stainless steel pin-in-head torx screws shall be furnished for door hardware and all mounting brackets. Through bolts shall be used for securing latch keeper, clothes hook and panel-to-stile brackets. A clothes hook shall be furnished for each door with heavy duty hardware option. Hinges shall be adjustable to hold doors of unoccupied compartments partially open or fully closed.

*\*\*To specify Institutional hardware, replace end of specification paragraph with: .67 option* All door hardware, U-channels, and angle brackets shall be type-304 stainless steel with satin finish: one-piece, full-height hinges shall be 16 gauge (1.6mm); one-piece door keepers shall be 11 gauge (3.2mm); one-piece, full-height U-channels and angle brackets shall be 18 gauge (1.2mm). U-channels shall be furnished to secure panels to stiles, and angle brackets furnished to secure panels and stiles to walls. Theft-resistant, stainless steel pin-in-head, torx screws shall be furnished for door hardware, U-channels, and angle brackets. Hinges shall allow locked compartment to be opened in emergency from outside by lifting door to disengage latch from keeper. Doors shall be equipped with a self-closing hinge. Through bolts shall be used for securing latch keeper and panel-to-stiles brackets. Threaded inserts shall be factory installed to secure all door hinges and latches.

\_\_\_\_\_ (insert one: Toilet Partitions, Dressing Compartments, Shower Dividers, Urinal Screens, Entrance Screens) shall be \_\_\_\_\_ Series (insert series number) of Bobrick Washroom Equipment, Inc., Clifton Park, New York; Jackson, Tennessee; Los Angeles, California; Bobrick Washroom Equipment Company, Scarborough, Ontario; Bobrick Washroom Equipment Pty. Ltd., Australia; and Bobrick Washroom Equipment Limited, United Kingdom.