

Features

- Solid polypropylene plastic.
- Elongated closed-front seat.
- Contoured seat for user comfort.
- Quick-Release™ hinge caps snap open and seat pulls forward for removal.
- Quick-Attach™ stainless steel fastener allows for top-mount screwdriver only install.



Codes/Standards











IAPMO/ANSI Z124.5

KOHLER® One-Year Limited Warranty

See website for detailed warranty information.

Available Color/Finishes

Color tiles intended for reference only.

| Color | Code | Description |
|--|------|-----------------|
|  | 0 | White |
|  | W2 | Earthen White |
|  | 96 | Biscuit |
|  | 47 | Almond |
|  | NY | Dune |
|  | 55 | Innocent Blush™ |
|  | Y2 | Sunlight |
|  | NG | Tea Green |
|  | 95 | Ice™ Grey |
|  | G9 | Sandbar |
|  | 33 | Mexican Sand™ |
|  | 6 | Skylight |
|  | 45 | Wild Rose™ |
|  | K4 | Cashmere |
|  | 58 | Thunder™ Grey |
|  | 52 | Navy |
|  | 7 | Black Black™ |
|  | 12 | Jersey Cream |
|  | 17 | Teal |
|  | 53 | Raspberry Puree |

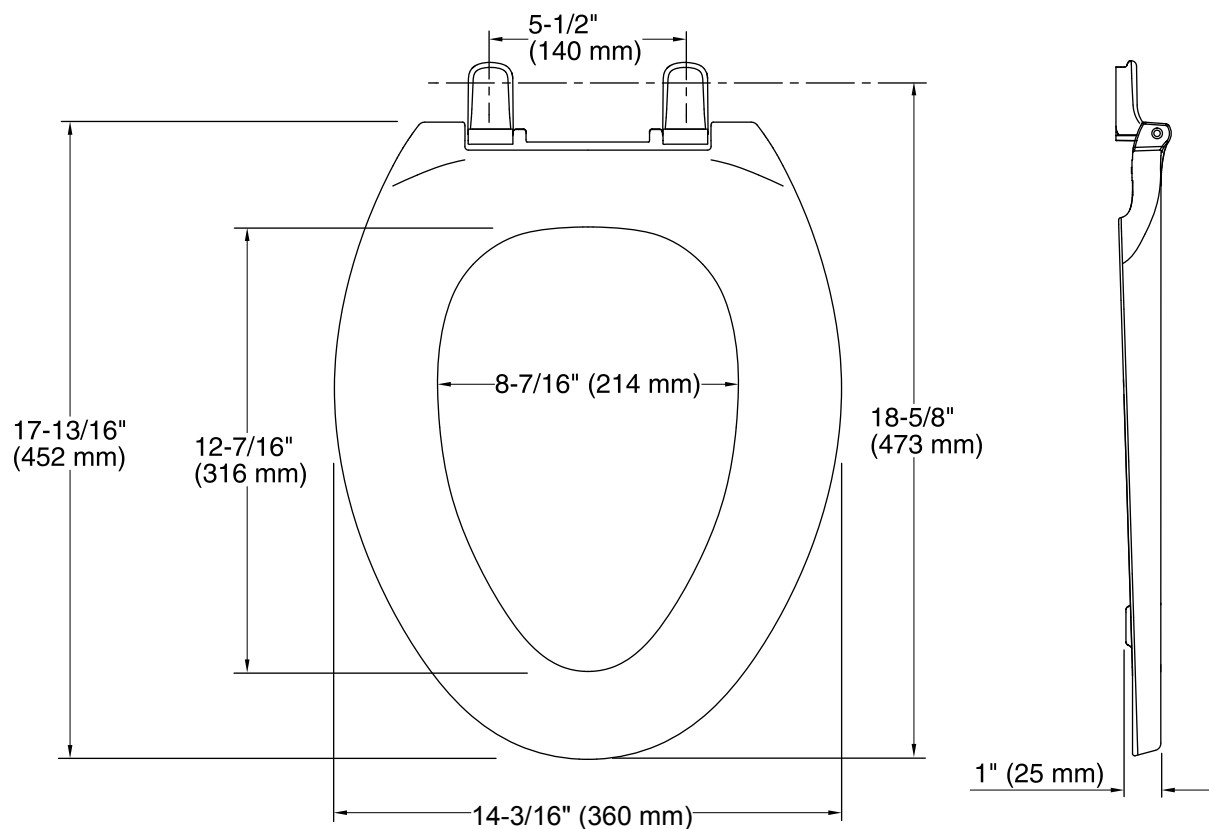

Technical Information

All product dimensions are nominal.

Seat shape type: Elongated

Seat front type: Closed front

Seat hinge type: Quick-Attach®, Quick-Release™

Seat-mounting holes: 5-1/2" (140 mm)

Notes

Install this product according to the installation guide.